



# ePort G11 Installation Guide

#VVXUD0101914



G11 Telemeter



Card Reader

Thank you for your purchase. Before you start, **please read these instructions thoroughly**, and then take a few moments to plan your installation.

You must have a signed ePort Connect Services Contract and a bank account assigned to this device for it to be able to accept credit card transactions. Please call Cantaloupe Customer Service at 1.888.561.4748, if you need activation documents.

## TOOLS REQUIRED FOR INSTALLATION

11/32" Socket  
1/4" Socket  
12" Extension Ratchet

Phillips Screwdriver Wire  
Cutters Power Drill\*  
3/16" & 3/8" Drill Bit\*

Multi-diameter Step Drill Bit,  
1/4"-3/4"\*\*

\* Required for surface-mount installations

# INSTALLATION PROCEDURES FOR THE G11 ePort®

The G11 ePort® works in vending machines with one or two full bill acceptor openings, allowing the acceptance of credit/debit transactions by using Card Swipe or RF technology payments. The G11 ePort solution works with the MDB vending interface. Additionally, the G11 has interfaces for Coin Pulse systems, along with a serial interface for PC based systems. In both Coin Pulse and Serial Modes, parameters can be modified to meet design requirements.

## KIT CONTENTS

Your LTE Wireless G11 ePort kit includes (Shown in Figure 1 unless noted):

- One G11 Telemeter with wireless modem installed (#VWUT0003002)
- One Card Reader (Bezel) (#V8SUK1235003)
- One Flange Mount Plate (#VXXUE0101235)
- One Bezel Drilling Template
- Two Magnetic Red Base Antennas (#V8WUP0101290)
- One Bezel Adapter Cable (#V6SUC1435003)
- Mounting Hardware: Four, 8-32 x 3/8" screws for mounting reader, and three self-drilling screws (#DCHZMPP83206)
- NOT PICTURED: Various POS stickers, Troubleshooting Checklist (#V8VUD1101435), RMA Procedure Sheet (#UXXUD0101552), this install guide (#V6XUE0520260), two Velcro strips, six Wire Ties for the Card Reader, and other order items.

**BEFORE YOU START**, read the instructions and take a few moments to plan your installation. Pick a mounting spot for the G11 Telemeter that will allow for ease of access and does not interfere with any moving parts in your vending equipment.

FIGURE 1 (items not to scale)



G11 Telemeter  
#VWUT0003002



Card Reader (Bezel)  
#V8SUK1235003

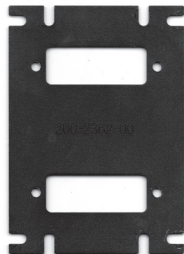

Flange Mount Plate  
#VXXUE0101235

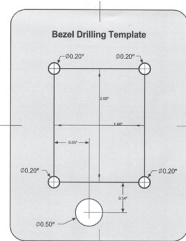

Bezel Drilling  
Template



Magnetic Red  
Base Antenna (2)  
#V8WUP0101290



Bezel Adapter Cable  
#V6SUC1435003

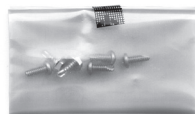

Mounting Hardware #DCHZMPP83206  
Four, 8-32 x 3/8" mounting screws, three  
self-drilling screws.

# 1. RSSI SIGNAL STRENGTH TESTING PROCEDURE

**Parts Required for RSSI Test:** G11 Telemeter and a Magnetic Red Base Antenna

**Optional:** A Card Reader

An RSSI test is done to determine if there is acceptable signal strength at a location before installing. The test also helps to place the antennas for the best reception. Where the antennas receive the best signal will also determine where to mount the G11 Telemeter inside the machine.

1. At the machine location, plug the antennas' cables into the ANTENNA ports found on the bottom of the G11 Telemeter. If a Card Reader is present, plug the cable from the Card Reader into the Telemeter cable's 6-pin black connector.
2. Disconnect the MDB connectors in the vending machine between the machine control board and the bill acceptor and connect the MDB Cable\* from the G11 Telemeter to the MDB connectors of the vending machine.
3. Place the antennas on top of, or inside the vending machine on a metal surface no closer than 6 inches apart to perform the test for the planned installation location. Make sure the antennas are not surrounded by signal weakening metal support brackets or located near the G11 Telemeter or the control board when the door is shut. This will improve connectivity to the cellular tower.
4. Wait until the G11 Telemeter has initialized, which is indicated by a blinking green LED. If a Card Reader is present the display will read "Swipe or Tap to Begin."
5. To begin testing, press the Telemeter's RSSI button. The Telemeter's LEDs will indicate signal strength. And if present, the Card Reader's display will show CSQ: XX, YY; where XX is signal strength and YY is Bit Error Rate. Use the following table to determine signal quality.



RSSI Button

QUALITY	TELEMETER LEDs	CSQ: XX	CSQ: YY
Very poor	none	00 to 07	Any value other than 00 for CSQ:YY indicates additional signal loss.
Poor	RED	08 to 09	
Good	RED and YELLOW	10 to 14	
Very good	RED, YELLOW and GREEN	15 to 19	
Excellent	RED, YELLOW, GREEN and BLUE	20 or greater	

6. If signal strength is poor or very poor, move the antennas to another location and wait 15 seconds until the signal stabilizes and then recheck.
7. Upon completion of testing, disconnect the G11 Telemeter's MDB cable and reconnect the vending machine MDB connectors.

\*When a Bill Recycler is present, the ePort must be plugged into the MDB bus ahead of the Bill Recycler to receive enough power to function properly.

## 2. RF/CARD SWIPE READER INSTALLATION

Choose the RF/Card Swipe Reader install method based on the design of the machine:

- A** Machine has a second opening for a bill acceptor - take note of screw sizes.
- B** Machine does not have a second opening for a bill acceptor.
- C** Machine has a POS window above the bill acceptor.
- D** Machine has a situation where a spacer is needed.

### **A** Machine opening for a bill acceptor

1. Power down the machine door and remove the blank plate that covers the opening.
2. Attach the Card Reader to the mounting plate using the four, 8-32 x 3/8" mounting screws.

**Correct screws must be used or the Card Reader may be damaged and the warranty will be void.**

3. Pass the assembly through the opening from inside the door of the machine and secure the mounting plate to the door with the original, blank plate screws.



**FIGURE 2**

### **B** Machine does not have a second opening for a bill acceptor

Mount the Card Reader on the outside surface of the vending machine:

1. Power down the machine door. If necessary, temporarily remove the bill acceptor during the drilling and mounting of the Card Reader.
2. Use a small level and tape to secure the included Bezel Drilling template (Figure 1) where you want the Card Reader to be located, and mark the four mounting screw holes and a hole for the cable.
3. Drill the four 3/16" holes for the mounting screws.
4. Drill the pilot hole for the 5/8" cable hole with a 3/8" bit and finish the hole by using either a 41/64" Greenlee knockout punch (#7211BB-1/2) or a 1/4"-3/4" step drill (McMaster-Carr part 8841A23).
5. Mount the Card Reader to the front of the door by using the four, 8-32 x 3/8" mounting screws.

### **C** Machine has a POS window above the bill acceptor

If the machine (i.e. the Royal 660, Royal 804, or the Dixie 522) has a POS window just above the bill acceptor (landscape doors), you must install the Card Reader with the Security Plate (#V6XUE0520260). A Security Plate is not included in the kit and can be purchased separately.

1. Power down the machine.
2. Remove the bill acceptor.
3. Remove the POS window above the bill acceptor.
4. Route the cable attached to the back of the Card Reader through the security plate (Figure 3).
5. Secure the security plate to the Card Reader with four, 8-32 x 3/8" mounting screws (Figure 3).
6. Pass this assembly through the POS window opening from inside the vending machine door, and attach the security plate to the door using the original hardware.
7. Replace the bill acceptor.

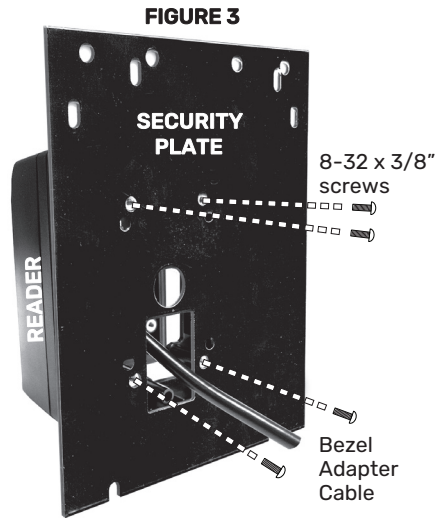

### **D** Machine has a situation where a spacer is needed

Some machines may require a spacer for the Card Reader to provide proper clearance for card swipes. If this is the case, a spacer and four, 8-32 x 1" long screws are available from Cantaloupe by contacting Customer Service at 888-561-4748. Request Spacer (#V6SUF1435002) and the four, 8-32 x 1" screws that are the correct length for an installation with a spacer. A shipping and handling charge will apply.

To complete the install, follow either the A, B or C instructions above depending on the design of the vending machine, and place the spacer between the cardreader and plate specific to the install and use the the four, 8-32 x 1" screws.

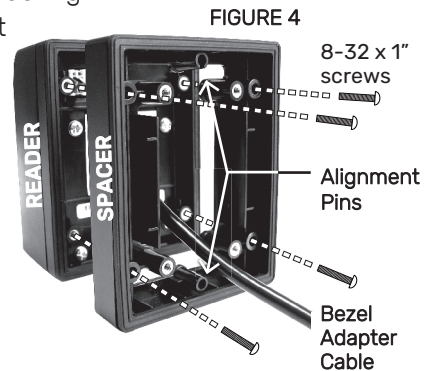

### 3. INSTALL THE G11 Telemeter

Follow these steps to install the G11 Telemeter in a machine:

1. Decide whether to mount the Telemeter using the three supplied self-tapping screws (Figure 5), or with a strip of Velcro attached to the back of the Telemeter.
2. Select a location in the main cabinet or door where the Telemeter is accessible for service and protected from moisture. To prevent any water intrusion, mount the Telemeter vertically with the cables hanging down. Make sure it will not interfere with any moving parts and allow for cable routing.
3. If mounting with screws, screw the self-tapping screws into the frame of the door or machine. If using Velcro, attach a strip of Velcro to the frame of the door or machine and stick the Telemeter to it.
4. Connect the Magnetic Base Antennas' (#V8W-UP0101290) MCX connectors into the ANTENNA ports found on the bottom of the Telemeter.
5. Place the antennas on top of, or inside the vending machine on a metal surface no closer than 6 inches apart. Make sure the antennas are not surrounded by signal weakening metal support brackets or lo-cated near the Telemeter or the control board when the door is shut. This will improve connectivity to the cellular tower. (Figure 6).
6. Tie the antenna cable to the nearest cable from the Telemeter (use soft loops, do not coil or bundle).
7. Disconnect the MDB connectors in the vending machine between the machine Control Board and the existing payment devices. Connect the MDB Cable from the G11 Telemeter to the MDB connectors going to the machine Control Board and the existing payment devices. Ensure the connectors latch firmly together.\*
8. Plug the 6-pin black connector from the Telemeter cable into the cable from the Card Reader. Ensure the connectors latch firmly together.
9. Either connect the DEX cable with the standard jack plug from the Telemeter to the vending machine DEX port (for remote DEX reporting), or leave the DEX cable hanging loose if no remote DEX is to be used. Test all connections made.

FIGURE 5

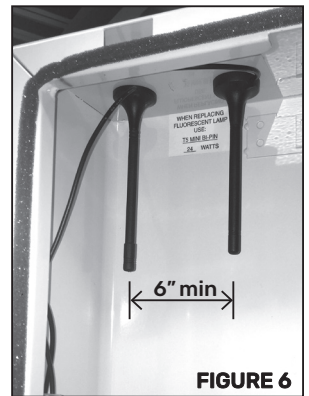
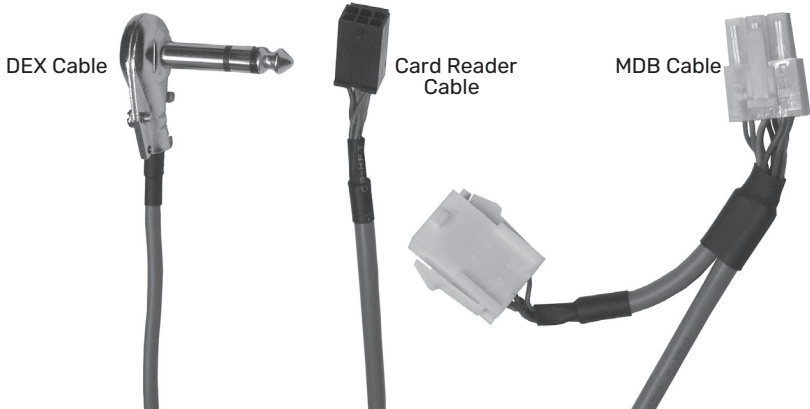

FIGURE 6

**\*NOTE:** When a Bill Recycler is present, the ePort must be plugged into the MDB bus ahead of the Bill Recycler so that it can communicate properly with the VMC.

**FIGURE 7 G11 TELEMETER CABLES**



## **4. VERIFY THE INSTALLATION**

1. Power up the vending machine and observe the LEDs of the G11 Telemeter. When the green LED blinks, the Telemeter has initialized. **If yellow and/or blue lights are on, do not power down the machine until only green blinking light remaining.**
2. Once the Telemeter has initialized the LTE Modem and connected to the wireless network, the Card Reader's display should read **"Swipe or Tap To Begin."**
3. At this point you can perform a test vend with a Cantaloupe Pass Card or credit card.
4. We recommend recording the ePort G11 Telemeter serial number and vending machine ID for accounting purposes.
5. Contact Cantaloupe Customer Care if you have any questions – 888-561-4748.

**You must have a signed ePort Connect Services Contract and bank account as-signed to this device for it to be able to accept credit card transactions. Please call Cantaloupe Customer Care at 888-561-4748, if you need activation documents.**



100 Deerfield Lane, Suite, 300  
Malvern, PA 19355

## **CANTALOUPE CUSTOMER CARE**

Contact Cantaloupe Customer Care for technical support and to request additional parts, information, and pre-authorization forms.

**Phone:** 888.561.4748

**FAX:** 610.989.9695

**Email:** [customerservice@cantaloupe.com](mailto:customerservice@cantaloupe.com)

**Online Store:** <https://store.cantaloupe.com/>

## **CANTALOUPE WEBSITE ADDRESSES**

### **Customer Website Login**

<https://www.seedlive.com>

### **Company Site**

<https://www.cantaloupe.com>

This device complies with Part 15 of the FCC Rules. Operation is subject to the following two conditions:

1. This device may not cause harmful interference
2. This device must accept any interference received, including interference that may cause undesired operation.

**#V VXUD0101912 REV I**

**All contents © Copyright 2022 Cantaloupe, Inc.  
All rights reserved.**

This guide was created during the Company's tenure as Cantaloupe, Inc.  
For contact information please visit [www.cantaloupe.com](http://www.cantaloupe.com).